

Compass SportTM

Owner's Manual



Compass SportTM

Center-Wheel Drive Power Chair

GP605 CC/GP605 SS

CONTENTS

INTRODUCTION	3-4
SAFETY.....	5-8
EMI/RFI	9
SPECIFICATIONS.....	10
ASSEMBLY/DISASSEMBLY.....	11-15
COMFORT SETTINGS.....	16-19
OPERATION/DIAGNOSTICS	20-26
BATTERY CHARGING	27-28
CARE AND MAINTENANCE	29
WARRANTY.....	30-31
REGISTRATION CARD.....	32

INTRODUCTION

Safety Guidelines

The symbols below are used in the owner's manual and/or on the product to identify warnings and to notify you of important safety information. Make sure you read and understand them completely.



WARNING! Indicate(s) a hazardous situation which, if not avoided, could result in death or serious injury. This icon is represented as a black symbol on a yellow triangle with a black border.



MANDATORY! Failure to perform mandatory actions can cause personal injury and/or equipment damage. This icon is represented as a white symbol on a blue dot with a white border.



PROHIBITED! Indicate(s) an action(s) that should not be performed under any circumstance. Failure to adhere can cause personal injury and/or equipment damage. This icon is represented as a black symbol with a red circle and red slash.

Safety Symbols

The symbols below identify warnings, mandatory actions, and prohibited actions. They can be found in the owner's manual and/or on the product. Make sure you understand all safety labels before operating the product. Do not remove safety labels from the product.



Read and follow the Owner's manual!



Explosive conditions exist!



Indoor use only!



Use only AGM or Gel-Cell batteries!



Avoid transmitters!



Hot surface!



Pinch/Crush Hazard!



Do not place into trash!



Electrical hazard!



Corrosive chemicals



Do not use personal electronic devices!



Recycle

SAFETY

Your *Compass Sport*[™] is a battery-operated personal mobility vehicle. Please exercise caution and consideration when you are operating it. Driving your *Compass Sport*[™] carefully and thoughtfully will help ensure your personal safety and the safety of other people.



MANDATORY! Read and follow the owner's manual before operating your power chair.

NOTICE Before operating your *Compass Sport*, please ensure you read and understand this owner's manual in its entirety. If any uncertainty exists after reading this manual, please ask for further instruction or training from your authorized Golden Dealer / Representative.

BEFORE GETTING ON YOUR *Compass Sport*[™]

- ◆ Check to be certain that the power is turned off. See "Operation" on pages 20-26. This will eliminate the possibility of accidentally activating the joystick and causing injury to yourself or to others.
- ◆ Check to be certain that your *Compass Sport*[™] is not in freewheel mode. See the "Operation" section on page 25.
- ◆ Flip up the armrests.
- ◆ If your chair is equipped with leg rests, move them to the sides.
- ◆ If your chair is equipped with a footrest, flip it to the "up" position.

GETTING ON YOUR *Compass Sport*[™]

- ◆ Carefully seat yourself comfortably and securely on the seat.
- ◆ Adjust the leg rests or flip down the footrest.
- ◆ Flip down the armrests.
- ◆ Fasten the lap belt.

GETTING OFF YOUR *Compass Sport*[™]

- ◆ Make certain that the power is turned off.
- ◆ Unfasten the lap belt.
- ◆ Flip up the armrests.
- ◆ Flip up the footrest, or move the leg rests to the sides.
- ◆ Carefully stand and step away from the chair.

MAXIMUM WEIGHT

Your *Compass Sport*[™] has been rated to a maximum payload (passenger and anything else being carried on the *Compass Sport*[™]) of **300 pounds**. Exceeding the maximum weight rating will void the warranty.



WARNING Exceeding the maximum weight capacity will void your warranty and may result in injury to yourself or others.

SAFETY

DRIVING ON AN INCLINE

- ◆ Drive with **caution** when attempting to negotiate any incline, even handicap access ramps.
- ◆ Try to keep your *Compass Sport*[™] **moving** when climbing an incline. If you do come to a stop, restart and accelerate slowly and carefully.



WARNING

- ◆ **Always** climb or descend a gradient by driving straight up or straight down the face of the slope.
- ◆ **Do not** traverse or drive across the face of a gradient.
- ◆ **Do not** attempt to negotiate an incline that is covered with snow, ice, cut or wet grass, leaves, or any other potentially hazardous material.
- ◆ **Do not** back down an incline.
- ◆ **Do not** try to descend or climb an incline that is greater than the maximum incline stated in the specifications section of this manual.



WARNING

If, while you are driving down a slope, your chair starts to move faster than you feel is safe, gently release the joystick and allow your *Compass Sport*[™] to come to a stop. When you feel that you again have control of your power chair, adjust the speed control to a lower setting, then push the joystick forward and continue safely down the remainder of the slope.

MEDICATION

Always check with your physician to determine if any of the medications you are taking may affect your judgment and/or your ability to operate your *Compass Sport*[™].

SAFETY

SAFETY RULES



WARNING

- ◆ **Do not** attempt to use your *Compass Sport™* on an escalator. Always use an elevator.
- ◆ **Do not** carry passengers on your power chair.
- ◆ **Do not** operate your *Compass Sport™* if it is not functioning properly.
- ◆ **Use caution** when driving on soft or uneven surfaces such as grass, gravel, and on decks where there is no railing.
- ◆ **Never** drive on the roadway, except when you must cross the street.
- ◆ **Always** cross streets at intersections and use the most direct route, making sure that your path is clear and that you are visible to motor traffic.
- ◆ It is **not recommended** to drive your *Compass Sport™* up or down a step or curb that is higher than 1 1/2 inches.
- ◆ **Never** back up or down a step or curb.
- ◆ **Never** operate your *Compass Sport™* while you are under the influence of alcohol.
- ◆ **Do not** operate or store your power chair where it will be exposed to rain, snow, mist, and below freezing temperatures.
- ◆ **Do not** operate your power chair on slippery, icy or salted surfaces.
- ◆ **Never** sit on your power chair when it is in freewheel mode and on an incline or decline.
- ◆ **Do not** modify your power chair in any way that is not authorized by Golden Technologies.
- ◆ **Do not** disassemble the tire. If disassembly is required, have your authorized Golden Compass Sport dealer perform any necessary maintenance or repair.
- ◆ **Do not** attempt to inflate the tires of your Golden *Compass Sport™*. Your Golden *Compass Sport™*, is equipped with foam-filled flat free tires that do not require inflation.
- ◆ **Never** sit on your *Compass Sport™* when it is being transported.
- ◆ **Always** fasten down your *Compass Sport™* securely with an approved tie-down system while transporting your power chair.

SAFETY

Please be sure to follow this important warning when transferring onto or off of the Golden Compass Sport power wheelchair:



WARNING

NEVER TRANSFER ON OR OFF OF THIS POWER WHEELCHAIR USING THE SEAT BACKREST FOR SUPPORT DURING TRANSFER. THE SEAT BACK MAY FOLD DOWN AND MAY CAUSE YOU TO LOSE YOUR BALANCE AND COULD RESULT IN PERSONAL INJURY.

Please be sure to follow this important warning about adding electrical or mechanical devices to your Golden Compass Sport power wheelchair:



WARNING

DO NOT ALLOW ANYONE EXCEPT AN AUTHORIZED GOLDEN TECHNOLOGIES, INC. REPRESENTATIVE TO CONNECT ANY ELECTRICAL OR MECHANICAL DEVICE TO YOUR COMPASS SPORT™. UNAUTHORIZED ACCESSORIES WILL VOID THE WARRANTY AND MAY CAUSE INJURY.

Please be sure to follow this important warning if you encounter a problem with your mobility device.



WARNING

Should you encounter a problem with the operation of your mobility device such as a mechanical or electrical problem immediately stop using the product. Disconnect the batteries then contact the dealer from whom you purchased your mobility device for evaluation of the problem and repair if needed.

EMI/RFI

The rapid development of electronics, especially in the area of communications, has saturated our environment with electromagnetic (radio) waves that are emitted by television transmitters, cellular phones, citizen's band radios (CBs), amateur radios (ham radios), wireless computer links, microwave transmitters, paging transmitters, etc. These electromagnetic (EM) waves are invisible and increase in strength the closer one gets to the source of transmission. When these energy waves act upon electrical devices and cause them to malfunction or to function in an erratic or uncontrolled manner, they are referred to as *Electromagnetic Interference* (EMI) or *Radio Frequency Interference* (RFI).

EMI/RFI AND YOUR *Compass Sport*[™]

All electrically powered vehicles, including power chairs are susceptible to EMI/RFI. This interference could result in abnormal, unintended movement of a power wheelchair.



WARNING **Unintended movement or brake release could cause an accident or injury.**

The FDA has determined that each make and model of power chair can resist EMI/RFI to a certain level. The higher the level of immunity, the greater the degree of protection from EMI/RFI measured in volts per meter (V/m). The FDA has also determined that current technology is capable of providing 20 V/m of immunity to EMI/RFI, which would provide useful protection against common sources of interference. This product has been tested and has passed an immunity level of 20 V/m.

EMI/RFI RECOMMENDATIONS



PROHIBITED! Do not turn on or use hand-held personal electronic communication devices such as cellular phones, walkie-talkies, and CB radios while your power chair is turned on.

- ◆ Be aware of any nearby transmitters (radio, television, microwave, etc.) on your intended route and avoid operating your chair close to any of those transmitters.
- ◆ Turn off the power if your *Compass Sport*[™] is going to be in a stationary position for any length of time.
- ◆ Be aware that adding accessories or components or modifying your power chair may make it more susceptible to EMI/RFI.
- ◆ If unintended movement or brake release occurs, turn your power chair off as soon as it is safe to do so.
- ◆ Report all incidents of unintended movement or brake failure to your Golden representative or to Golden Technologies, Inc. at (800) 624-6374.



WARNING **Turn off your power chair as soon as it is safely possible if unintended or uncontrollable motion occurs or if unintended brake release occurs.**

SPECIFICATIONS

Model	GP605 CC	GP605 SS
Medicare Code	K0823	K0822
Maximum Incline	6 degrees	6 degrees
Weight Capacity	300 lbs.	300 lbs.
Maximum Speed	4 mph	4 mph
Operating Range ¹	19.5 miles	19.5 miles
Ground Clearance	3.25"	3.25"
Turning Radius	19.5"	19.5"
Type Batteries	2-U1	2-U1
Colors	Red, Blue	Red, Blue
Charger	Off Board	Off Board
Controller	Dynamic Linx, 40 Amp	Dynamic Linx, 40 Amp
Dimensions:		
Length	39"	39"
Width (outside of tires)	24"	24"
Height (ground to top of back of seat)	38" – 40"	40" – 42"
Height (ground to top of back of headrest)	45" – 50.5"	47" – 52.5"
Ground to Top of Seat	21" – 23"	19" – 21"
Number of Seat Height Positions	3	3
Size of Increments	1"	1"
Weight of Unit: (assembled)	185 lbs.	179 lbs.
Base	92 lbs	92 lbs
Seat (18 X 18 Solid Pan Seat)		40 lbs.
Seat (18 X 18 Captain's Chair Seat)	46 lbs.	
Batteries	U1 - 22 lbs	U1 - 22 lbs
Tires:	Flat Free	Flat Free
Center Drive Wheels (2)	10"	10"
Casters (4)	6"	6"
Standard Seat:	Captain's Seat	Captain's Van/Pan
Back Height-no headrest	19"	23"
Back Height with headrest	26.5" – 29.5"	30.5" – 34.5"
Width x Depth (Adjustable Depth)	18" x 18"	18" x 18", 20" x 18", 20" x 20"
Color	Gray Vinyl	Coffee/Sand, Charcoal/Gray
Electric Rise Seat (Option)	N/A	N/A
Pneumatic Rise Seat (Option)	N/A	N/A
Footrest:	Yes	Yes
Height adjustable	3" - 7"	3" - 7"
Angle adjustable	0 – 35 degrees	0 – 35 degrees
Length adjustable (Option)	Yes	Yes
Warranty:		
Frame	Lifetime	Lifetime
Drive Train	13 months	13 months
Electronics ²	13 months	13 months

1. Battery range will vary due to rider weight, drive surface, and terrain.

2. Electronics warranty excludes batteries.

Literature is current at the time of printing. Golden Technologies reserves the right to make changes to the product or literature at any time.

ASSEMBLY/DISASSEMBLY

Your *Compass Sport™* is shipped partially disassembled in order to maximize the protection of all its parts during the shipping process. Please follow the instruction below to quickly and easily assemble the power chair for your use.

NOTICE You will need only basic tools. If you do not have the required tools, or if you do not feel capable of safely assembling your power chair, please contact your local Golden Technologies, Inc. representative.

Main Components

1. Frame with power module, controller cable & connectors for battery cables.
2. Battery box covers
3. Seat assembly
4. Joystick
5. Batteries (Two – U1)
6. Seat Belt



Joystick



Batteries

ASSEMBLY / DISASSEMBLY

NOTICE

Before operating or assembling your *Compass Sport™*, be sure to connect the power cable from the batteries to the Linx power module. Your *Compass Sport™* will not power up or operate without completing this step.

1. Remove the rear battery cover. Refer to “Accessing the batteries” on page 14.
2. Plug the power cable into the Linx power module. See figure 1 on page 13.
3. Replace the rear battery cover.

SEAT INSTALLATION/REMOVAL



WARNING The standard (18 x 18) seat assembly weighs about 46 pounds.

Please ask for help if you do not feel capable of safely lifting that much weight. Removal of arms will significantly reduce the weight of seat.



WARNING Be sure the seat is correctly installed and locked before operating

your power chair.



WARNING Never pull on the arms or use them as a handle to move the power

chair as they could inadvertently pull out of the receiver bar causing injury.

INSTALLATION

1. To install the seat, align the seat post stinger on the bottom of the seat with the hole in the seat post on the chair. See figures 2 and 3 on page 13.
2. Push down on the seat and rotate the seat until it aligns and locks in place. See figure 3 on page 13.
3. Attach arms by loosening the arm width adjustment knobs (See figure 18 on page 19). Insert left arm into left receiving tube and tighten the arm width adjustment knob. Repeat with right arm.
4. Attach joystick to right arm. See “Joystick Installation/Removal” on page 13.
5. Connect the joystick cable. See figure 5 on page 13.
6. Lift the Backrest Angle Adjustment Lever (See figure 4 on page 13) and while holding the lever, lift the seat back to an upright angle.
7. To remove, simply reverse the process above.

REMOVAL

1. With one hand brace the seat back. With the other hand lift the Backrest Angle Adjustment Lever and while holding the lever, lower the back of the seat to the seat.



WARNING Lifting the Backrest Angle Adjustment Lever will cause the back to automatically close towards the seat. Improper handling may result in injury.

2. Disconnect the cable from the joystick. See figure 5 on page 13.
3. Remove arms by loosening the arm width adjustment knobs (See figure 18 on page 19). Remove by pulling arms out of the receiving tubes.
4. Lift the seat up and off the seat post receiver.

ASSEMBLY / DISASSEMBLY

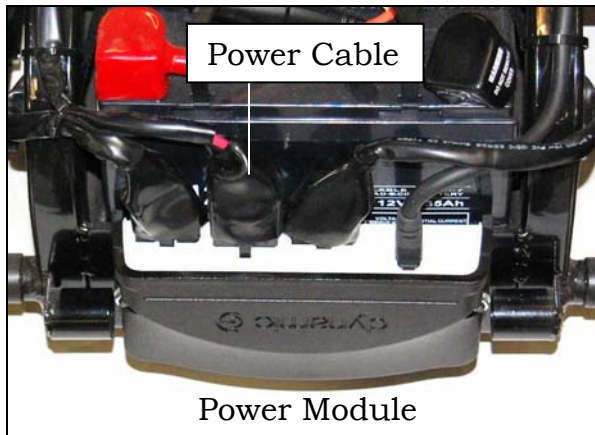

Figure 1

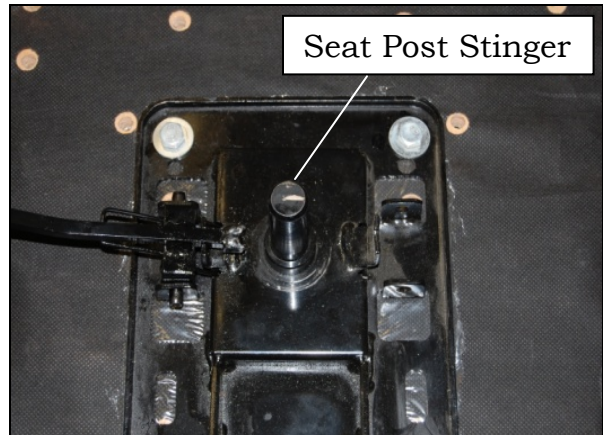

Figure 2

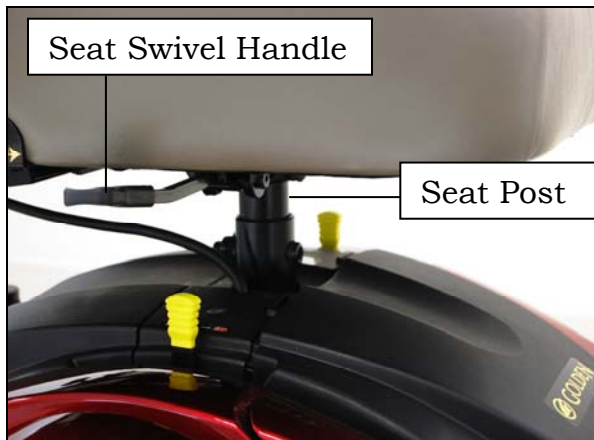

Figure 3



Figure 4

JOYSTICK INSTALLATION/REMOVAL

1. Loosen the joystick adjustment knob. See figure 5.
2. Slide the joystick assembly into the joystick bracket to the desired position.
3. Tighten the adjustment knob.
4. Connect the joystick cable.
5. To disassemble, turn off joystick controller and then reverse the process above.

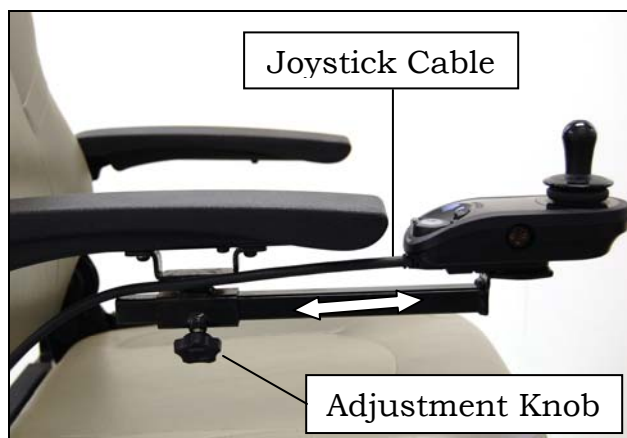

Figure 5

ASSEMBLY / DISASSEMBLY

ACCESSING THE BATTERIES

1. Remove the seat. Refer to “Seat Removal” on page 12.
2. Locate the two “Battery Box Covers”, front and rear.
3. Remove one of the covers by lifting up on the outer edge of the cover. See figure 6.
4. Remove the opposite cover by lifting up on the outer edge of the cover.



Figure 6

NOTICE There is a “Battery Connection Diagram” located on the inside of the rear battery box cover. See figure 7.

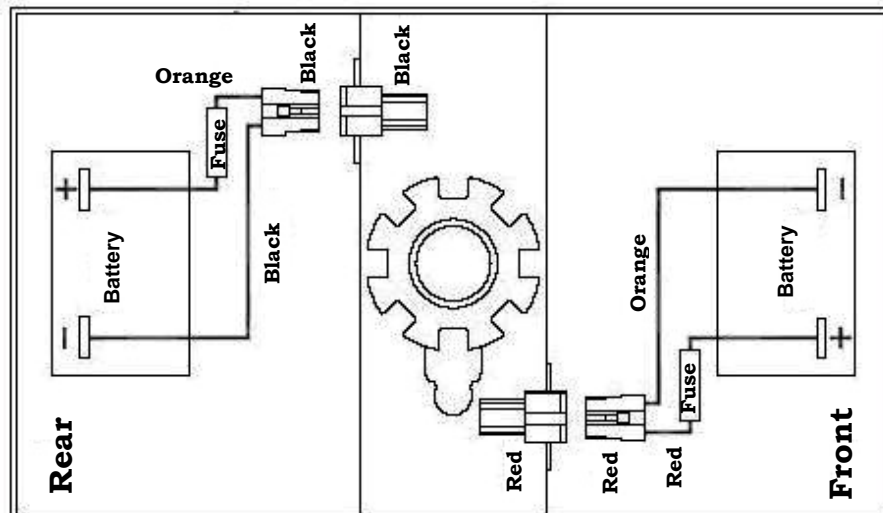

Figure 7



WARNING The batteries weigh 22 pounds each. (Battery weights may vary depending on the manufacturer). Please ask for help if you do not feel capable of safely lifting that much weight.

ASSEMBLY/ DISASSEMBLY

BATTERY INSTALLATION/REMOVAL

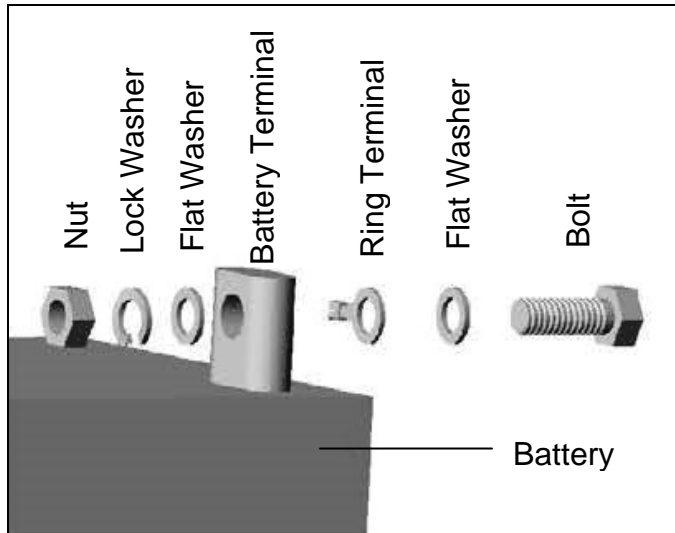

Figure 8

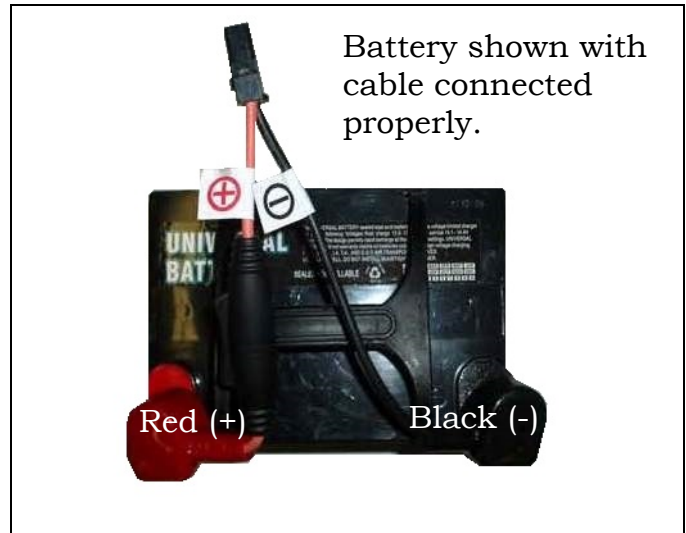

Figure 9

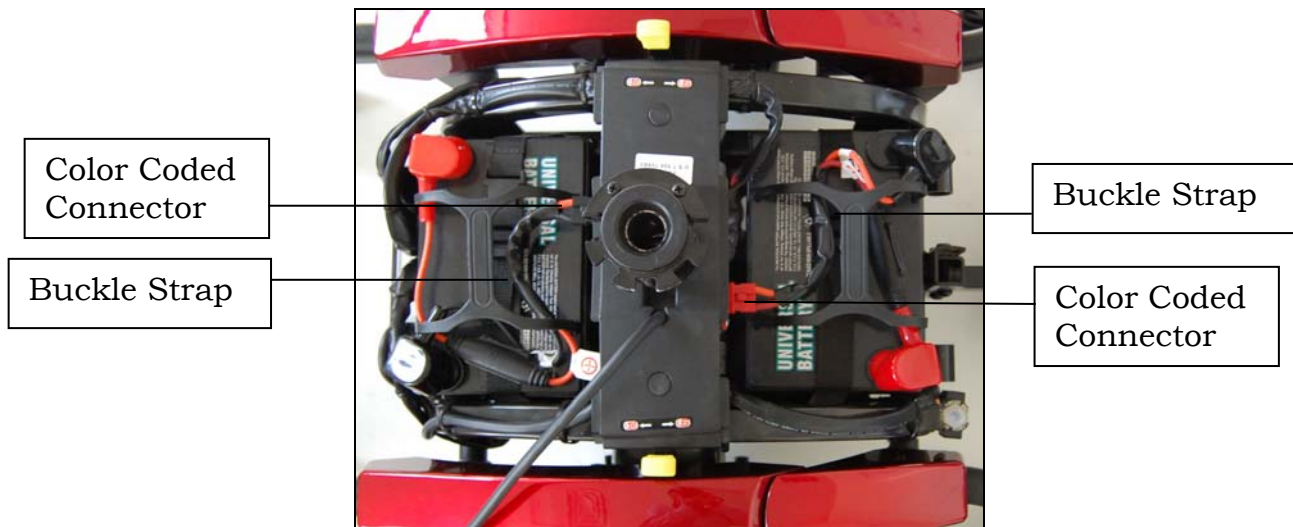

Figure 10

1. Use the screws, washers, and nuts provided to connect the positive (red booted) connector of each cable to the positive (+) terminal of each battery. See figure 8 and figure 9.
2. Use the screws, washers, and nuts provided to connect the negative (black booted) connector of each cable to the negative (-) terminal of each battery.
3. Place the batteries into the battery box. Be certain the color coded connectors match. Refer to the "Battery Connection Diagram" shown in figure 7 on page 14.
4. Secure the batteries in place using the buckle straps. See figure 10.
5. Connect each color coded battery cable connector to the corresponding connector on the main wire harness. See figure 10.
6. Install both battery box covers.
7. To disassemble, reverse the above process.

COMFORT SETTINGS

You may be spending a great deal of time on your *Compass Sport™*. To provide you with the maximum seating comfort, Golden Technologies, Inc. has designed this power chair to incorporate the following adjustments for operator comfort.

COMFORT SETTINGS

- | | | |
|-------------------|--------------------|--------------------|
| 1. Seat height | 2. Headrest height | 3. Backrest angle |
| 4. Armrest angle | 5. Footrest angle | 6. Footrest height |
| 7. Armrest height | 8. Armrest width | 9. Joystick length |



WARNING

Make certain that the power to your *Compass Sport™* is turned off before making any adjustments, to eliminate the risk of the joystick being accidentally bumped and activating the power chair.

NOTICE

If you do not feel capable of safely making these adjustments, please contact your local Golden representative.

SEAT HEIGHT ADJUSTMENT

The seat post is a design that is adjustable in height. Adjustment is made by removing the seat post bolt, raising or lowering the seat post to the desired height and re-installing the seat post bolt. See figure 11.



Figure 11

COMFORT SETTINGS

HEADREST HEIGHT ADJUSTMENT

1. Standing behind the chair, push and then release the clamp on the left post of the headrest while you are pulling up or pushing down on the head rest. See figure 12.
2. The headrest will “click” to a stop in one of the preset positions.
3. Repeat step 1 until the headrest is at the desired height.

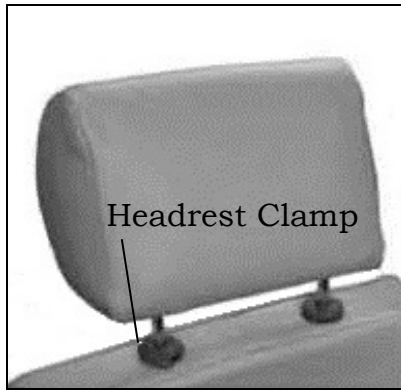

Figure 12



Figure 13

BACKREST ANGLE ADJUSTMENT

NOTICE The backrest can be folded down to minimize chair height during transport.

1. Pull up on the adjustment lever (see figure 13) and push against the backrest until the backrest is in the desired position.
2. Release the lever.
3. To return the backrest to the upright position, pull up on the lever and move the backrest to the desired position.

ARMREST ANGLE ADJUSTMENT

1. Lift armrest up. See figure 14.
2. Turn jam nut counter-clockwise with a 14mm wrench to loosen.
3. Turn the adjustment bolt using a 6mm Allen wrench to raise or lower the armrest-angle. Turning the bolt counter-clockwise will raise the angle. Turning the bolt clockwise will lower the angle. Turn until desired angle is reached.
4. Re-tighten jam nut by turning clockwise.
5. Repeat steps 1-4 on the other armrest.

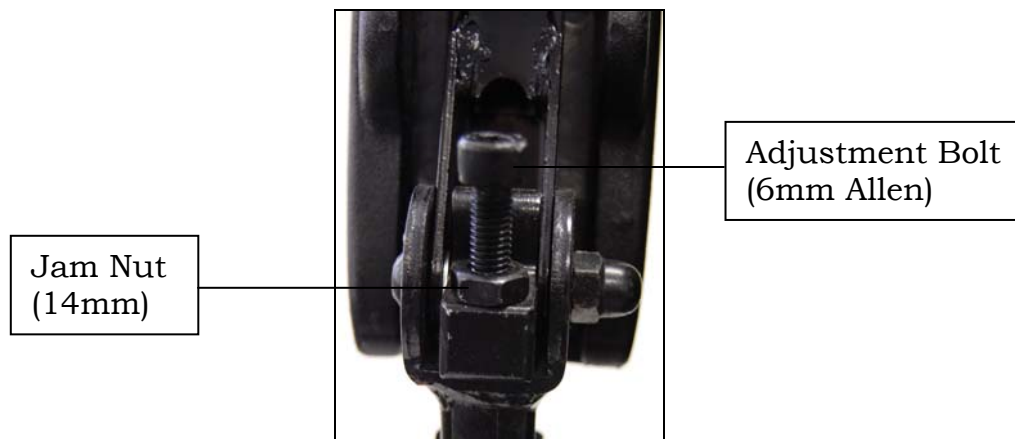

Figure 14

COMFORT SETTINGS

FOOTREST ANGLE ADJUSTMENT

1. Fold the footrest upward for easy access to the angle adjustment bolt. See figure 15.
2. Turn the jam nut counter-clockwise with a 17mm wrench to loosen.
3. Use an 8mm Allen wrench to turn the adjustment bolt. Turn the adjustment bolt counter-clockwise to increase the footrest angle. Turn the adjustment bolt clockwise to decrease the footrest angle.
4. When the desired footrest angle is reached, re-tighten the jam nut.

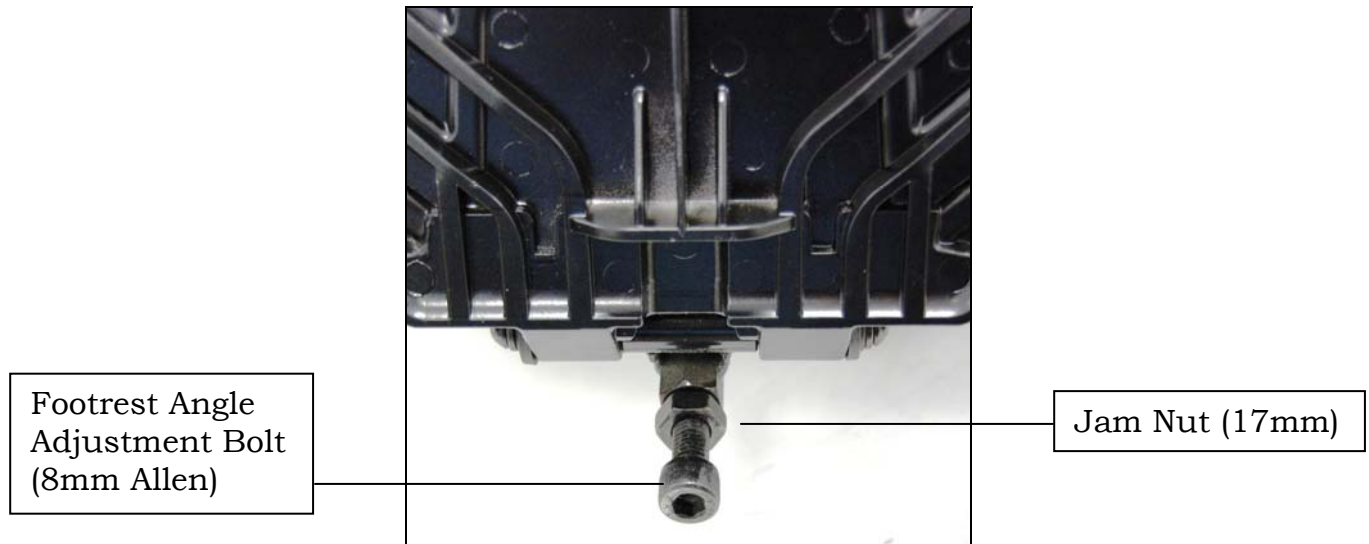

Figure 15

FOOTREST HEIGHT ADJUSTMENT

1. Remove front cover.
2. Use a 13mm socket and 5mm Allen wrench to remove the bolts. See figure 16.
3. Slide the footrest to the desired height.
4. Align the bolt holes in the footrest and the footrest bracket.
5. Install and tighten the bolts.

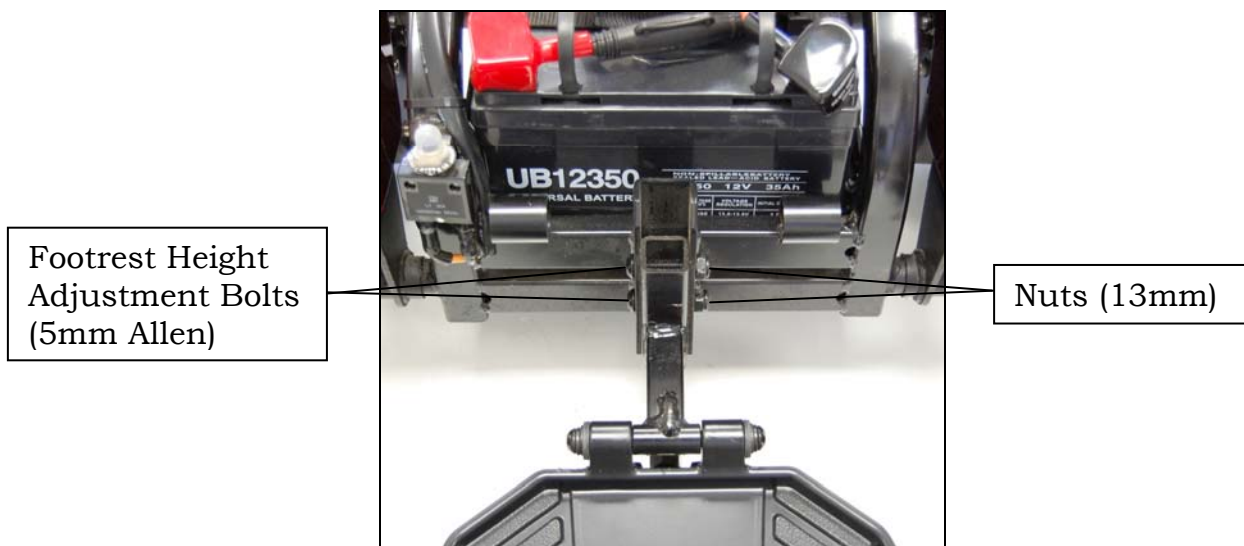

Figure 16

COMFORT SETTINGS

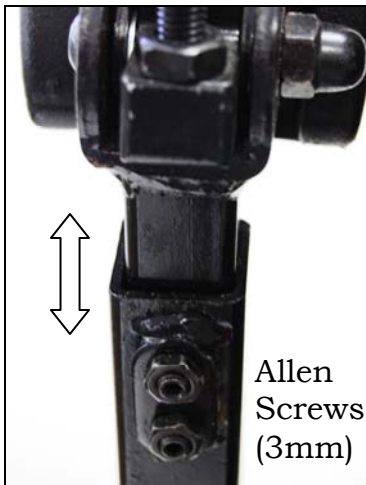

Figure 17



Figure 18



Figure 19

ARMREST HEIGHT ADJUSTMENT

1. Loosen the two armrest height adjustment screws on the outside of the armrest with a 3mm Allen wrench until you can slide the armrest up and down freely. See figure 17.
2. Raise or lower the armrest to the desired position.
3. Retighten the two adjustment screws to lock the armrest into that position.
4. Repeat steps 1-3 to adjust the opposite arm.

ARMREST WIDTH ADJUSTMENT

1. Loosen the adjustment knob at the rear of the seat. See figure 18.
2. Slide the arms in or out to the desired width.
3. Tighten the adjustment knob to secure the arm.
4. Repeat steps 1-3 to adjust the opposite arm.

JOYSTICK BRACKET LENGTH ADJUSTMENT

1. Loosen the adjustment knob. See figure 19.
2. Slide the joystick holder in or out to the desired position.
3. Tighten the adjustment knob.

OPERATION

Your *Compass Sport™* is simple to operate. However, for your safety and the safety of others, Golden Technologies, Inc. recommends that you carefully read and understand the following operating instructions. We also recommend that you practice operating your *Compass Sport™* in an area free of any obstacles. Once you have gained confidence in your ability to control your power chair, you will more easily be able to operate it in normal daily conditions.

CAUTION Before turning on the power of your *Compass Sport™*, take note of your environment and set your speed control accordingly. (See “The Speed Control Buttons” figure 20) For indoor driving, we recommend that you select the lowest speed setting. For outdoor driving, we recommend that you select a speed setting at which you feel comfortable, safe, and in control of your power chair. Familiarize yourself with the features of your *Compass Sport™* described below and follow the instructions to safely operate your power chair.



Figure 20



WARNING The surface of the joystick can potentially get hot when it is exposed to strong sunlight for long periods.

OPERATION

DRIVING: Joystick Power On/Off Button



To turn on the power to your *Compass Sport*TM, press the power button. If the system is healthy, the Status indicator (through the Power Button) will light up green, and the Battery Gauge will display the current battery status.

Power Off

If there is a fault with the system when powering up, the status indicator will indicate a fault with a series of red flashes (see “Diagnostics”) on page 24. If the fault is one that prevents the power chair from driving, then the battery gauge will flash continuously.



To turn off the power to your *Compass Sport*TM, press the power button; the system will power down and the Status indicator will switch off.

Power On

NOTICE In the unlikely event that the power chair is in a runaway situation, press the power button to perform an EMERGENCY STOP.

Drive Inhibit Indication

Drive inhibit mode is indicated by the battery gauge with a right-to-left light sequence.

The light sequence starts with the green LED on the right-hand side, and one-by-one, each LED will switch on then off. When the sequence completes at the left-most red LED, it begins again at the right-hand side.

The light sequence continues until the error condition has been cleared.

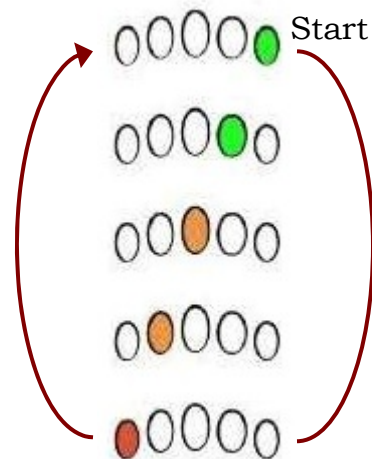

Drive Inhibit Light Sequence

OONAPU

OONAPU (“**Out Of Neutral At Power Up**”) is a safety feature that prevents accidental movement of the wheelchair, either when powering up, or when the wheelchair comes out of an inhibit state.

If the LINX LE System is turned on (or comes out of an inhibit state) while the joystick is not in the center position, an OONAPU **warning** is displayed. During an OONAPU warning, the battery gauge LEDs will flash continually to alert the user, and the chair will not drive. If the joystick is returned to the center position within five seconds, the warning will clear and the wheelchair will drive normally.

However, if the joystick remains out of neutral for longer than five seconds, an OONAPU **error** will occur; the error is displayed by the Status indicator flashing red, and the chair will not drive. To clear the error, return the joystick to the neutral position and power the unit off and then on again.

OPERATION

The Joystick

The joystick (see figure 20 on page 20) controls the speed (up to the maximum limit set by the speed dial) and direction of your power chair.

Pushing the joystick away from the neutral (center) position will move your *Compass Sport*[™] in the direction that the joystick is pushed.

- ◆ The farther forward or backward you push the joystick, the faster your power chair will go.

To operate your power chair, gently push the joystick in the direction in which you want to travel.

- ◆ Gentle operation of the joystick will provide you with smoother changes in speed and direction.
- ◆ Sharp or jerky operation of the joystick will result in quick and drastic changes in direction and speed.

NOTICE For your safety, the controller automatically sets the reverse speed, acceleration, and deceleration in proportion to the speed control setting.

NOTICE When you are not pushing on the joystick, or when you release the joystick, the joystick will automatically return to the neutral position, the chair will decelerate, as the electromagnetic brakes are applied, and come to a smooth stop.

Controlling Maximum Speed



The speed dial allows you to limit the maximum speed of the power chair (that is, the speed when the joystick is fully deflected) to suit your preference and environment.

The dial offers 10 discrete steps between the lowest speed (dial set to the left) and the highest speed (dial set to the right).



As a visual reminder, a speed symbol (shown left) is positioned just below the speed dial to indicate the low and high positions of the speed dial.

Horn



The horn button is located above the power button. Press the horn button to sound the horn. The horn will sound for as long as the horn button is pressed.

OPERATION

The Battery Gauge

The battery gauge comprises five different LEDs (1 x RED, 2 x AMBER, 2 x GREEN), located above the horn button. The number of LEDs lit depends on the status of the battery, as shown.

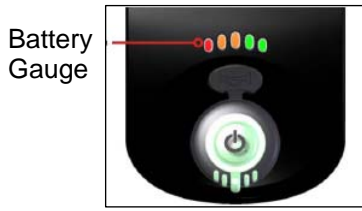

Battery Gauge

The battery gauge LEDs are also used to display charging information. Refer to “Battery Charging” on pages 28-29.

Normal Operation

Battery Gauge

Battery Level



Fully charged



Consider charging the battery



Battery needs charging

High voltage warning



A high voltage warning is indicated by all LEDs on, and the green LEDs flashing. This occurs when the battery voltage level has risen above the high voltage warning set-point.

Low voltage warning



A low voltage warning is indicated with the left-most LED flashing. This occurs when the battery voltage level has dropped below its low voltage warning set-point. **Charge the batteries immediately.**

Cut-off voltage



When the battery voltage drops below the battery cut-off voltage:

- The first (red) LED will flash on the battery gauge.
- The status indicator (under the power button) will display a flash code 2 or 7.
- The horn will sound once every 10 seconds.

OPERATION/DIAGNOSTICS

For Compass Sport Units with the LINX Controller



If, when powered up, there is an error with the system, then the status indicator will flash red. The number of flashes will indicate the type of error. These are described in the table below.

Status Indicator

Flash Code	Description	
1	Remote / joystick error	Check Linx connections and wiring. Replace the Linx Control Unit.
2	Network or configuration error	Check Linx connections and wiring. Replace the Linx Control Unit.
3	Left motor error	Check the left motor, connections and cabling.
4	Right motor error	Check the right motor, connections and cabling.
5	Left park brake error	Check the left park brake, connections and cabling.
6	Right park brake error	Check the right park brake, connections and cabling.
7	Module error (other than Remote)	Check Linx connections and wiring. Replace the Power Module.

NOTICE The LINX modules are not user serviceable. Do not attempt to repair Linx modules.

OPERATION



Figure 21

FREEWHEEL MODE

- ◆ To disengage the gears and put your power chair in freewheel mode, pull the freewheel levers forward towards the front of your chair. See figure 21.
- ◆ To re-engage the gears and take your chair out of freewheel mode, push the levers back towards the rear of your chair. See figure 21.



WARNING Never put your power chair in freewheel mode when it is on a slope or incline of any type.



WARNING Never put your power chair in freewheel mode while you are operating your power chair.

THERMAL ROLLBACK

Your *Compass Sport™* is equipped with a safety system. A microprocessor monitors the operating temperatures of the controller. In the event of excessive heat occurring in the controller, the controller will decrease the speed of your chair. This is done to reduce the load on the electrical system and allow the components to dissipate heat. The controller will automatically set the chair's speed back to full normal when the operating temperature returns to normal levels.

THE MAIN CIRCUIT BREAKER

The main circuit breaker is another safety feature incorporated into your *Compass Sport™*. This device monitors the amount of current being drawn from the batteries when the chair is in use. When the motors are heavily strained and too high a current draw is being placed on the batteries, the main circuit breaker will trip and bring your chair to a stop. See figure 22 on page 26.

OPERATION



Figure 22

Reset Button

If the main circuit breaker trips, please wait for approximately 1 minute and then push the reset button to reset the main circuit breaker. See figure 22.

NOTICE Usually, the thermal rollback feature is more sensitive than the main circuit breaker. We recommend that you turn off the power to the chair and wait for five minutes when the chair suddenly loses speed or power. Doing so will allow the overheated electrical components to cool to their normal operating temperatures.

Additional features available for your *Compass Sport*™

Length Adjustable Footrest – Optional Equipment Required

The Compass Sport™ optional footrest will provide you with the ability to extend the footrest by simply adjusting two screws.

Footrest Extension – Optional Equipment Required

The Compass Sport™ optional footrest extension will provide you with the ability to extend the footrest even further for added foot space when required by simply sliding the extension out to the desired position.

Swing-away Desk Arm – Optional Equipment Required

The Compass Sport™ swing-away desk arm option will provide you with the convenience of positioning your chair close to a work surface such as a table or desk.

To swing the desk arm simply push on the side of the joystick until the joystick swings to the retracted position.

BATTERY CHARGING



WARNING You must use only the charger that is supplied with your *Compass Sport™*. The use of any other charger on this power chair will void the warranty. Using unauthorized chargers may also result in severe damage to the batteries and/or damage to the chair. Using the wrong charger may also be a hazard.

Operational Range

Depending on the use, the terrain, and the driving conditions, the U1 batteries of your *Compass Sport™* will provide up to 19.5 miles of operation with a user weight of 300lbs.



WARNING! Corrosive chemicals contained inside battery.
Explosive battery conditions exist.



WARNING! Charger surface can become HOT.
Electrical hazard!

BATTERIES AND CHARGING

Battery maintenance is the most important part of maintaining your power chair. Keeping the batteries fully charged helps to extend battery life. Use the following guidelines to help keep your batteries in optimum condition.

IMPORTANT! New batteries **MUST** be fully charged prior to the initial use of your power chair.

Charge new batteries for 12 hours even if the battery gauge already shows a full charge. This is to condition your new batteries for maximum performance.

- For daily use, keep batteries fully charged. We recommend that you plug in the off-board charger after each use and charge 6-8 hours.

“For best results please charge your batteries overnight after every use.”

- If you are not going to use the power chair for more than a week, **fully charge** the batteries and then disconnect them from the power chair. See figure 9 on page 15.

NOTICE

Charging Guidelines Checklist to Maximize Battery Life

- ✓ Use only the automatic off-board charger supplied for all routine charging.
- ✓ Never use an automotive or wet type charger.
- ✓ Avoid deep discharges and never drain the batteries completely.
- ✓ Do not leave batteries in a low state of charge for extended periods. Charge a discharged battery as soon as possible.
- ✓ Fully recharge batteries regularly.
- ✓ Always store batteries fully charged.
- ✓ Check stored batteries once a month and recharge as necessary.

BATTERY CHARGING

CHARGING THE BATTERIES

Your *Compass Sport's* charging system is designed for your safety and for your convenience. Follow the steps below to recharge the batteries.

1. Position your *Compass Sport™* close to a standard wall electrical outlet.
2. Turn off the power on the joystick.
3. Remove the charger from its storage pouch.
4. Insert the matching charger plug into the joystick's charging socket that is located on the outside edge of the joystick. See figure 23.
5. Insert the plug at the other end of the charger power cord into a standard electrical wall outlet.
6. Disconnect the charger power cord from the wall outlet and from the joystick charging socket when the batteries are fully charged.

NOTICE The batteries should be fully charged in approximately eight hours. A full charge is indicated when the battery charger LED is green and the 5 battery gauge LEDs (1 x RED, 2 x AMBER, 2 x GREEN) on the joystick are illuminated.

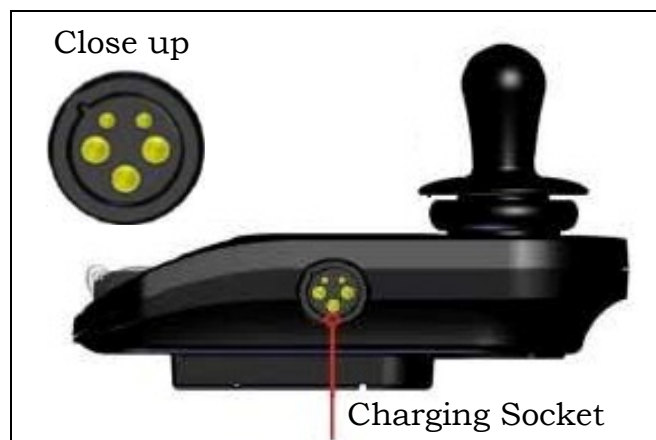

Figure 23

Battery Charging

The battery gauge will indicate the system is being charged by cycling between a left-to-right light sequence, and then display the approximate battery charge state at the end of the sequence.

Driving is prevented (inhibited) while the system is being charged.

The system does not have to be powered up when charging the battery, however, if it is not powered up, then the battery gauge will not display the charging state/light sequence.

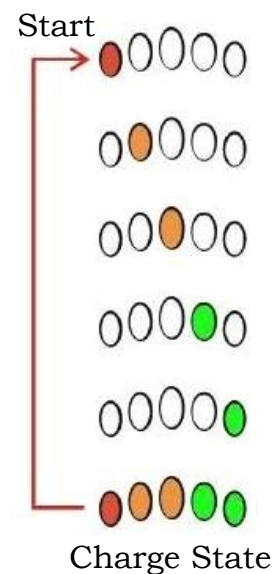

CARE AND MAINTENANCE

Your *Compass Sport*[™] is designed to require minimal maintenance. We recommend that you periodically check the following:

Tire Tread: Regularly visually inspect the tire tread. If the remaining tread is less than 1/32 of an inch, have your local Golden representative replace the worn tires.

Joystick and Controller: Protect the joystick and controller from adverse weather conditions. Moisture will damage the controller and void your power chair's warranty.

Battery Terminals: Regularly inspect the condition of the battery terminals. Make certain that they are not corroded. Also check to see that the terminals are securely tightened.

Cleaning: Use only a water-dampened soft cloth to clean the ABS shroud. The shroud has a protective coat that is very easy to maintain.



WARNING

Do not use free-flowing water to clean your *Compass Sport*[™]. Water and extreme temperatures are the main elements that can adversely affect your power chair and its performance.

Water, Rain, Sleet, and Snow

Water, in any form, will cause electronic malfunction or corrosion of the electrical components, connections, and the chair frame.

Temperature

- ◆ At extremely low temperatures, the batteries of your power chair may freeze, preventing your *Compass Sport*[™] from operating.
- ◆ At extremely high temperatures, your power chair may operate at slower speeds due to the controller's thermal rollback feature that is designed to prevent damage to the motors and to the other electrical components of the chair.

Consumer Limited Warranty *Power Wheelchairs*

The following warranty is granted only to the INITIAL Consumer who has purchased our product and commences on the Date of Purchase by the Consumer from an Authorized Golden Technologies' Provider. The Consumer must have a warranty registration card filed with Golden Technologies to receive service.

The warranty covers the following power wheelchair models unless otherwise noted:

- | | | |
|-------------------|-----------------------|---------------------|
| ◆ Alanté Jr GP200 | ◆ Compass GP600 | ◆ Compass TRO GP615 |
| ◆ Alanté GP201 | ◆ Compass GP601 | ◆ Compass GP620 |
| ◆ Alanté DX GP204 | ◆ Compass Sport GP605 | ◆ LiteRider GP160 |
| ◆ Alanté LT GP215 | ◆ Alanté Sport GP205 | ◆ LiteRider GP162 |

Limited Lifetime Warranty:

In the event of defective materials or workmanship, Golden Technologies will repair or replace at our option any of the following **structural frame components** found to be defective by an authorized Golden Technologies representative:

- | | | |
|----------------|----------------|--------------|
| ◆ Steel Frame* | ◆ Frame Welds* | ◆ Seat Post* |
|----------------|----------------|--------------|

*The GP615TRO, GP620, GP204, GP215, GP160, GP162, and the GP205 are warranted for FIVE YEARS.

Thirteen-Month Limited Warranty:

For the period of thirteen months from the date of purchase, in the event of defective materials or workmanship, Golden Technologies will repair or replace at our option any of the following **structural frame components** found to be defective by an authorized Golden Technologies representative:

- | | | |
|------------------|----------------|------------|
| ◆ Caster Beam | ◆ Caster Forks | ◆ Footrest |
| ◆ Anti-Tip Forks | ◆ Armrests | |

For the period of thirteen months from the date of purchase, in the event of defective materials or workmanship, Golden Technologies will repair or replace at our option any of the following **drive train components** found to be defective by an authorized Golden Technologies representative:

- | | |
|--------------------------|---------------------------------------------|
| ◆ Motor/Gearbox Assembly | ◆ Brake Assembly (electrical function only) |
|--------------------------|---------------------------------------------|

Note: An increase in operating noise of the motor/gearbox DOES NOT constitute a defect. With normal wear and tear, operating noise is expected to increase.

For the period of thirteen months from the date of purchase, in the event of defective materials or workmanship, Golden Technologies will repair or replace at our option any of the following **electronic assemblies** found to be defective by an authorized Golden Technologies representative:

- | | | |
|-------------------------|-------------------|----------------------------------------------|
| ◆ Electronic Controller | ◆ Battery Charger | ◆ Wire Harness(es)
(excludes boot covers) |
|-------------------------|-------------------|----------------------------------------------|

NOTICE While charging batteries, it is normal for the battery charger to heat up. Heat coming from the battery charger DOES NOT constitute a defect.

Consumer Limited Warranty ***Power Wheelchair (continued)***

For the period of thirteen months from the date of purchase, in the event of defective materials or workmanship, Golden Technologies will repair or replace at our option any of the following **parts** found to be defective by an authorized Golden Technologies representative:

- | | | |
|-------------------------------------------------------------------------------------------------------------------|---------------------------------------------------------------------------------------------------------------|-----------------------------------------------------------------------------------------------------------------|
| <ul style="list-style-type: none"> ◆ Bearings ◆ Bushings ◆ Seat swivel mechanism | <ul style="list-style-type: none"> ◆ Rubber Components
(excludes tires and all wear parts) | <ul style="list-style-type: none"> ◆ Plastic Components
(excludes body & all wear parts) |
|-------------------------------------------------------------------------------------------------------------------|---------------------------------------------------------------------------------------------------------------|-----------------------------------------------------------------------------------------------------------------|

Items not mentioned or listed are covered at the discretion of Golden Technologies. Any accessories, standard or optional, supplied by Golden Technologies, are covered for a period of one year from the date of purchase with the particular unit.

Warranty Exclusions:

Golden Technologies does not provide warranty on any of the following items which may require replacement due to the normal wear and tear of day to day usage:

- | | | |
|----------------------------------------------------------------------------------------------------------------------------|-------------------------------------------------------------------------------------------------------------------|--------------------------------------------------------------------------------------|
| <ul style="list-style-type: none"> ◆ Tires and Tubes ◆ ABS Plastic Shrouds ◆ Armrest Pads | <ul style="list-style-type: none"> ◆ Motor Brushes ◆ Bulbs/Fuses ◆ Battery Cases | <ul style="list-style-type: none"> ◆ Brake Pads ◆ Upholstery |
|----------------------------------------------------------------------------------------------------------------------------|-------------------------------------------------------------------------------------------------------------------|--------------------------------------------------------------------------------------|

This warranty also excludes the following:

- ◆ Batteries (Please consult battery manufacturer for any implied warranty)
- ◆ Loss or theft of components
- ◆ Damage caused by:
 - Battery fluid spillage or leakage
 - Abuse, misuse, accident or negligence.
 - Improper operation, maintenance or storage.
 - Commercial use or use other than normal.
 - Repairs and/or modifications made to any part without the specific consent of Golden Technologies.
 - Exceeding the specified weight capacity of the unit.
 - Accessories other than those supplied or approved by Golden Technologies.
 - Failure to adhere to the product instructions
 - Acts of Nature, such as lightning strikes, earthquakes, etc....
 - Circumstances beyond the control of Golden Technologies.

◆ ANY PARTS ALTERED OR REPAIRED BY UNAUTHORIZED PERSON.

Warranty Service:

Warranty Service must be performed by an authorized Golden Technologies representative. Golden Technologies reserves the right to replace warranted part(s) with refurbished or new part(s) at our discretion. All labor charges, service calls, transportation costs or any other charge(s) associated with the installation of any warranted part(s) are the responsibility of the consumer. Warranty is for the replacement of the parts only and does not include freight for the replacement parts. Consumers are not to return any item(s) to Golden Technologies without prior written authorization. Any damages incurred while warranted part(s) are in transport are the sole responsibility of the consumer.

There is no other express warranty.

Implied warranties, including those of merchantability and fitness for a particular purpose are excluded. Liabilities for consequential damages are excluded.

This warranty gives you specific rights and you may also have other rights which may vary from state to state.